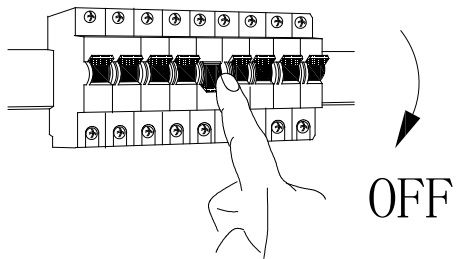
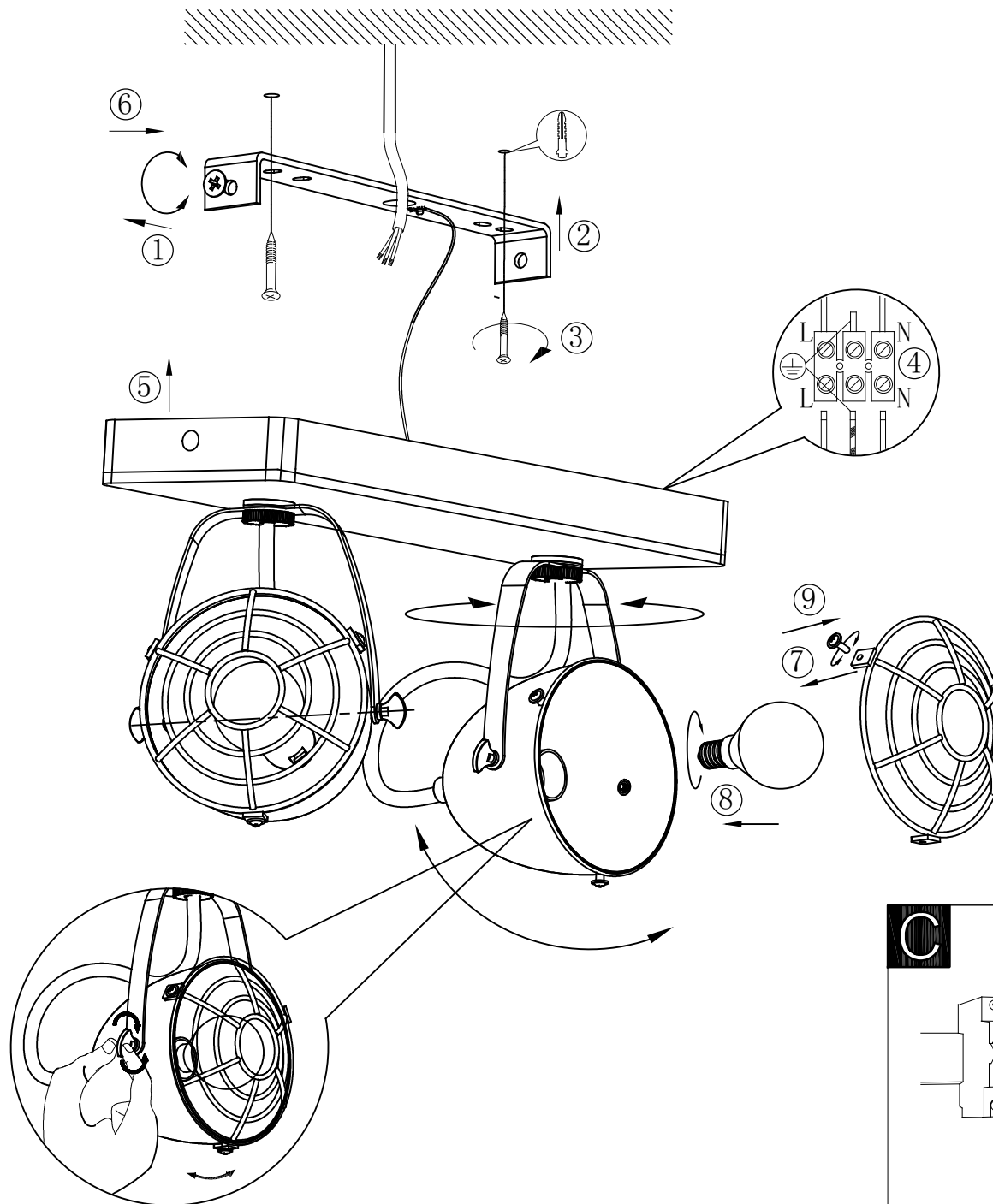
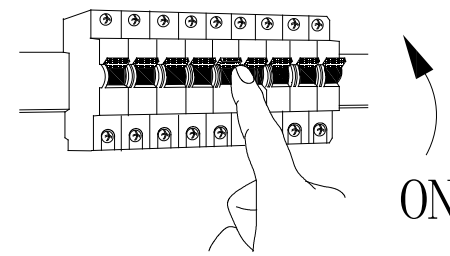

**A****B****C**

B49077  
www.eglo.com